

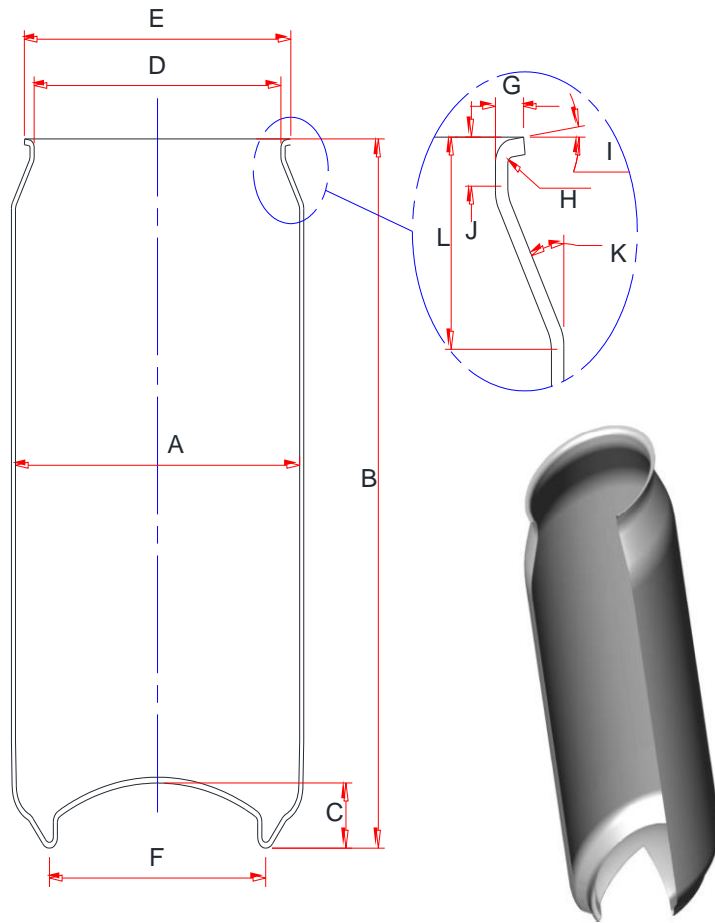

Finished Can - Customer Specification



Item	Description	mm	+/-	inch	+/-
A	Outside Body Diameter	53.070	0.01	2.0894	0.0004
B	Factory Finished Can Height	134.09	0.25	5.279	0.010
C	Dome Depth	9.70	0.13	0.382	0.005
D	Neck Plug Diameter	50.00	0.13	1.969	0.005
E	Flange Diameter	54.54	max	2.147	max
F	Stand Diameter	46.36	ref	1.825	ref
G	Flange Width	2.10	0.20	0.083	0.008
H	Over Flange Radius	1.55	ref	0.061	ref
I	Flange Angle	0-7	deg	0-7	deg
J	Seaming Clearance	3.05	min	0.120	min
K	Neck Angle	33.0	deg	33.0	deg
L	Neck Height	9.80	ref	0.386	ref
1	Dome Reversal Pressure (min)	6.32	Bar	93	PSI
2	Axial Load Strength (min)	85	KG	834	N
3	Freeboard	14.1	ref	0.56	ref
4	Brimful Capacity (ml)	279	3	279	3

Protective Coatings:

External Base Protection: **Rim Coat**

Internal Lacquer: **Modified Epoxy**

DATE:	REVISION DESCRIPTION:	ISSUE:



THIS IS A CONTROLLED
DOCUMENT ISSUED BY
CBC

Manufacturer:	Ceylon Beverage Can Ltd	DATE: 7/6/2016	DRAWN BY: C BC
Can Size:	185ml x 202 body x 200 neck	ISSUE NO: 1	CHECKED BY: PR
Product:	Aluminium Beverage Can	DOCUMENT NO: 5356-104-C01-04	